



**User Guide**  
**10.4” Industrial Open Frame Monitor**  
**OF10L630-P1-5RT**

## Table of Contents

<b>INTRODUCTION .....</b>	<b>3</b>
<b>IMPORTANT SAFETY INSTRUCTIONS .....</b>	<b>4</b>
2.1 ELECTROSTATIC DISCHARGE (ESD).....	5
2.2 GROUNDING METHODS.....	5
2.3 FCC STATEMENT.....	5
2.4 ELECTROMAGNETIC CAPABILITY.....	5
2.5 IMPORTANT LCD INFORMATION.....	6
<b>PACKAGING LIST .....</b>	<b>7</b>
<b>PRODUCT DESCRIPTION.....</b>	<b>8</b>
4.1 GENERAL INFORMATION .....	8
4.2 FEATURES .....	8
<b>MECHANICAL DRAWINGS .....</b>	<b>9</b>
<b>TOUCH SCREEN SOLUTION.....</b>	<b>10</b>
6.1 INTRODUCTION TO FIVE-WIRE RESISTIVE TOUCH SCREEN .....	10
<b>INSTALLING THE DISPLAY .....</b>	<b>11</b>
7.1 SIGNAL CABLE.....	11
7.1.1 <i>VGA Signal Shielding Cable Connection</i> .....	11
7.2 STARTING THE MONITOR .....	12
7.3 VESA WALL MOUNT INSTALLATION .....	13
<b>LCD DISPLAY OPERATION.....</b>	<b>14</b>
8.1 SIMPLE TROUBLESHOOTING GUIDE .....	14
8.1.1 <i>Brief FAQ</i> .....	14
8.1.2 <i>Additional Troubleshooting Chart:</i> .....	15
<b>APPENDIX .....</b>	<b>16</b>
9.1 CLEANING THE MONITOR.....	16
9.2 TOUCH SCREEN DRIVER INSTALLATION.....	17
9.3 RMA (RETURN MATERIAL AUTHORIZATION) SERVICE .....	18

## Introduction

This user manual is designed for American Industrial Systems, Inc. Included is a comprehensive overview of the systems designed by American Industrial Systems.

All rights are reserved. None of this document shall be duplicated, stored in a retrieval system, or transmitted by all means, electronic, mechanical, photocopying, recording, or otherwise, without the prior written permission of American Industrial Systems, Inc. No copyright or patent liability is assumed with respect to the use of the information included herein. Although every precaution has been taken in the preparation of this documentation, neither responsibility is assumed for errors or omissions by the publisher and the author, nor is any liability assumed for damages caused by the use of the information included herein.

The information in this documentation is subject to change without prior notice and does not stand for a commitment on the part of American Industrial Systems, Inc.

The information included in this manual may be subject to technical changes especially due to constant product upgrades.

The attached documentation does not involve any guarantee on the part of American Industrial Systems, Inc. regarding technical processes described in the manual or any product characteristics specified in the manual. American Industrial Systems, Inc. does not accept any liability for any printing errors or other inaccuracies in the manual unless it can be proven that American Industrial Systems, Inc. is aware of such errors or inaccuracies or that American Industrial Systems, Inc. overlooks these as a result of gross negligence and American Industrial Systems, Inc. has failed to get rid of these errors or inaccuracies for this reason.

American Industrial Systems, Inc. clearly informs the users that this manual only encloses a general description of technical processes and instructions which may not be applicable in every single case. In cases of doubt, please contact American Industrial Systems.

This manual is protected by copyright. All rights are reserved by American Industrial Systems, Inc. Copies of all or part of this manual or translations into different languages may only be made with the prior written consent. American Industrial Systems, Inc. points out that the information included in this manual is constantly being updated in line with the technical changes and improvements made by American Industrial Systems, Inc. to the products and thus this manual only reflects the technical status of the products at the time of printing.

© 2013 by American Industrial Systems, Inc.

## Important Safety Instructions

This chapter also includes information on approval and interference inhibition of your unit. Please abide by the warnings and instructions on the unit and in the manual. Please read these instructions carefully before using the product and save it for later reference.

- ◆ Follow all warnings and instructions marked on the product.
- ◆ Unplug this product from the wall outlet before cleaning. Clean the product with a damp soft cloth. Do not use liquid or aerosol cleaners as it may cause permanent damage to the screen.
- ◆ Do not use this product near water.
- ◆ Do not place this product on an unstable cart, stand, or table. The product may fall, causing serious damage to the product.
- ◆ This product should be operated from the type of power indicated on the marking label. If you are not sure of the type of power available, consult your dealer or local power company.
- ◆ This product is equipped with a 3-wire grounding type plug, a plug having a third (grounding) pin. This plug will only fit into a grounding-type power outlet. This is a safety feature. If you are unable to insert the plug into the outlet, contact your electrician to replace your obsolete outlet. (For AC version only) Do not defeat the purpose of the grounding-type plug.
- ◆ Do not allow anything to rest on the power cord.
- ◆ Do not locate this product where persons will walk on the cord.
- ◆ Never push objects of any kind into this product through cabinet slots as they may touch dangerous voltage points or short out parts that could result in a risk of fire or electric shock.
- ◆ Never spill liquid of any kind on the product.
- ◆ Do not attempt to service this product yourself, as opening or removing covers may expose you to dangerous voltage points or other risks and will void the warranty. Refer all servicing to qualified service personnel.
- ◆ Unplug this product from the wall outlet and refer servicing to qualified service personnel under the following conditions:
  - ◇ When the power cord or plug is damaged or frayed. If liquid has been spilled into the product.
  - ◇ If the product has been exposed to rain or water.
  - ◇ If the product does not operate normally when the operating instructions are followed. Adjust only those controls that are covered by the operating instructions since improper adjustment of other controls may result in damage and will often require extensive work by a qualified technician to restore the product to normal operation.
  - ◇ If the product has been dropped or the cabinet has been damaged.
  - ◇ If the product exhibits a distinct change in performance, indicating a need for service.

The display system was built and tested by American Industrial Systems, Inc. in accordance to prescribed safety conditions, and in a safe condition.

In order to retain this condition and maintain safe operation, the users must abide by the instructions and warnings

- ◆ The electrical installations in the room must not violate the requirements of the local (country-specific) regulations.
- ◆ The unit must be used in accordance with these instructions.
- ◆ Pay close attention that there are no cables, especially power cables, in areas where ambulatory traffic may interfere.
- ◆ Only use the power cord supplied with the package. Don't use injured or damaged power cords.

## 2.1 Electrostatic Discharge (ESD)

A sudden discharge of electrostatic electricity can damage electrostatic-sensitive devices or circuit. Adequate packaging and grounding techniques are essential fundamentals to avoid damage. The following precautions should be always taken:

1. Deliver printed circuit boards in electrostatic-safe containers such as cartons, boxes or anti-static bags.
2. Keep electrostatic-sensitive parts in their containers until they reach an electrostatic-free station.
3. Follow adequate grounding when sensitive PCB's, components, or assemblies are in close vicinity of the unit.
4. Store electrostatic-sensitive PCB's in a protective packaging such as insulating foam.

## 2.2 Grounding Methods

Protect against electrostatic damage of the unit by taking the following preventative measures:

1. Cover workstations with approved anti-electrostatic material.
2. In order to guarantee that the operator is grounded, provide a wrist strap connected to the working bench.
3. Properly ground tools and equipment.
4. For extra protection use anti-electrostatic mats, heel straps, or air ionizers.
5. Handle electrostatic-sensitive components, PCB's, and assemblies with care nearby the case or the edge of the board.
6. Prevent contact with pins, leads, or circuitry.
7. Switch off power and input signals before plugging and removing connectors or testing equipment.
8. Keep the work area free from non-conductive materials such as ordinary plastic assembly aids and Styrofoam.
9. Use field service tools with conductivity, such as screwdrivers, pliers, and vacuum cleaners.
10. Always put drives, PCB's, and the like with the component-side down on the working bench.



## 2.3 FCC Statement

This equipment has been tested and found to comply with the requisites for a Class A digital device, pursuant to Part 15 of the FCC Rules. These limits are designed to provide reasonable protection from harmful interference when the equipment is operated in commercial environments. This equipment generates, uses, and radiates radio frequency energy, and if it is not installed and used in accordance with the instruction manual it may cause harmful interference to radiofrequency communications. Operation of this equipment in residential areas may cause harmful interference in which case the operator will be required to correct the interference at his or her own expense.





## 2.4 Electromagnetic Capability

The display systems have been designed for industrial use. The most recent version of the EMC guidelines (EMC Directive 2004/108/EC) is applied. If the users modify and/or add to the equipment (e.g. installation of add-on cards), then the prerequisites for the CE conformity declaration (safety requirements) may no longer be applicable.

## 2.5 Important LCD Information

CAUTION		
Read manual prior to installing the product. The operation of products depends on you reading and following the information in this manual. Re-check your work prior to operating the product.		
EVENT	EFFECT	PREVENTION
	Sunlight shines directly will cause the panel damage.	You should avoid placing the product under direct sunlight.
	If the product is close to the wet ground such as grassplot, the moisture between panel and glass will make the product malfunction.	You should avoid placing the product in wet environment.

## Packaging List

Item	Description	Note
 A small booklet or manual with a computer monitor icon on the cover and the text "USER MANUAL" at the top.	<b>1 User Manual</b>	
 A standard compact disc (CD) with a black center hole and a reflective surface.	<b>1 CD for Touchscreen Drivers &amp; Tools</b>	
 A power cord with a standard three-prong AC power plug on one end and a different connector on the other.	<b>1 Power Cord</b>	
 A black rectangular power adapter with a power cord attached to one side and a different connector on the other.	<b>1 Power Adapter</b>	

## **Product Description**

### **4.1 General Information**

The AIS 10.4" industrial console and Open Frame chassis-mount touch screen monitor is a fully-integrated, off-the-shelf unit (COTS) that combines high-performance touch technology, in an industrial-grade LCD panel, with a sleek front surface industrial design. AIS industrial Open Frame displays provide reliability, durability, and expected life. The rugged all steel frames and durable glass front surface provide the durability needed for demanding industrial environments. These displays are designed for point-of-sale (POS) transactions, self-service kiosk systems and industrial machinery builder applications.

### **4.2 Features**

- ◆ Long lasting product cycle for continuity thru all phases of project rollouts and servicing
- ◆ Exceptional quality and highly engineered industrial monitors
- ◆ Delivers drift-free operation with lifetime of 35 million finger touches
- ◆ All steel construction designed for harsh and industrial environments
- ◆ Supports Panel, Wall, and VESA arm mounting
- ◆ Easy-to-install console and Open Frame chassis-mount display
- ◆ Accuracy in high-use applications
- ◆ Supports Windows Embedded and Linux operating systems



# Mechanical Drawings (mm)

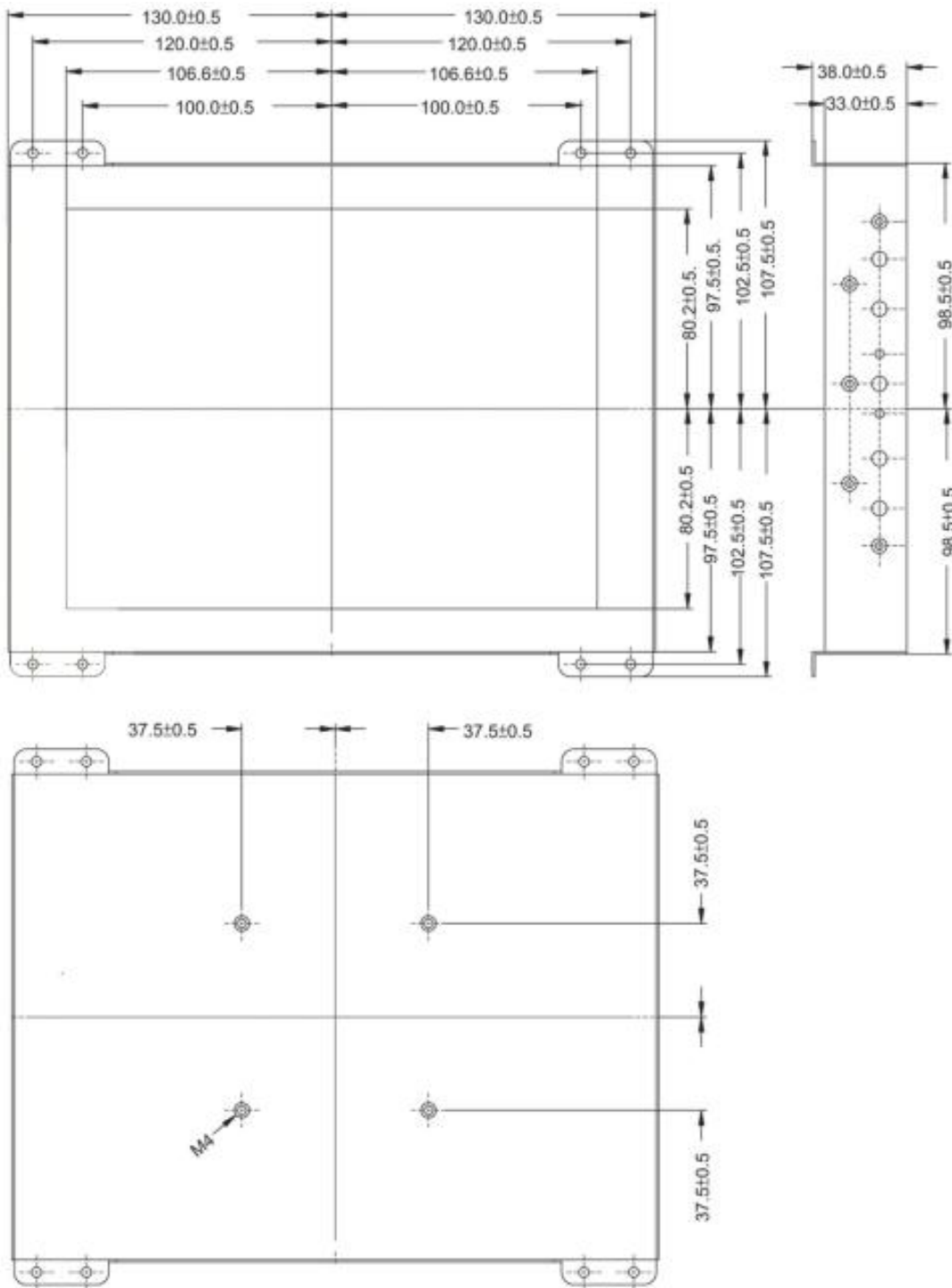

# Touch Screen Solution

## 6.1 Introduction to Five-Wire Resistive Touch Screen

The five-wire resistive touchscreens use a glass panel with a uniform resistive coating. A thick polyester coversheet is tightly suspended over the top of the glass, separated by small, transparent insulating dots. The coversheet has a hard, durable coating on the outer side and a conductive coating on the inner side.



When the screen is touched, the conductive coating makes electrical contact with the coating on the glass. The voltages produced are the analog representation of the position touched. The controller digitizes these voltages and transmits them to the computer for processing. The five-wire technology utilizes the bottom substrate for both X and Y-axis measurements. The flexible coversheet acts only as a voltage-measuring probe. This means the touchscreen will continue working properly even with non-uniformity in the cover sheet's conductive coating. The result is an accurate, durable and reliable touchscreen that offers drift free operation. The touchscreens are sealed against contamination and moisture. The coversheet is sealed to the glass substrate with an industrial grade caulk. This prevents wicking of fluid between the coversheet and glass. Also, the touchscreens are not air vented, thereby preventing fluid ingress through an air vent.

### Brief Specifications:

Subject	Details
Input Method	Finger, gloved hand, or stylus activation
Positional Accuracy	Standard deviation error is less than 0.080 (2 mm)
Resolution	Touchpoint density is based on controller resolution of 4096 x 4096
Touch Activation Force	Typically less than 4 ounces (113 grams)
Light Transmission	HL products: 80% +/-5% at 550 nm wavelength Enhanced products: 60% +/-5% at 550 nm wavelength
Update touchscreen driver or new information. Go to <a href="http://www.elotouch.com">www.elotouch.com</a>	

## Installing the Display

### 7.1 Signal Cable

#### 7.1.1 VGA Signal Shielding Cable Connection



1. Plug one end of the 15-pin signal cable to the video signal connector at the rear end of the PC system and the other end of the cable to your military display.
2. Secure the connectors with the screws on the cable connector at both ends.

## **7.2 Starting the Monitor**

1. Connect the Adapter to the monitor by the cord into the bottom of the monitor.
2. Connect the power cord to the adapter, and plug in the power to an outlet securely.

### 7.3 VESA Wall Mount Installation

This monitor conforms to the VESA Flat Panel Mounting Physical Mounting Interface standard which defines a physical mounting interface for flat panel monitors. It also corresponds with the standards of flat panel monitor mounting devices, such as walls and table arms. The VESA mounting interface is located on the back of your monitor.

To mount the monitor on an UL-listed certified swing arm or other mounting fixture, follow the instructions included with the mounting fixture to be used.

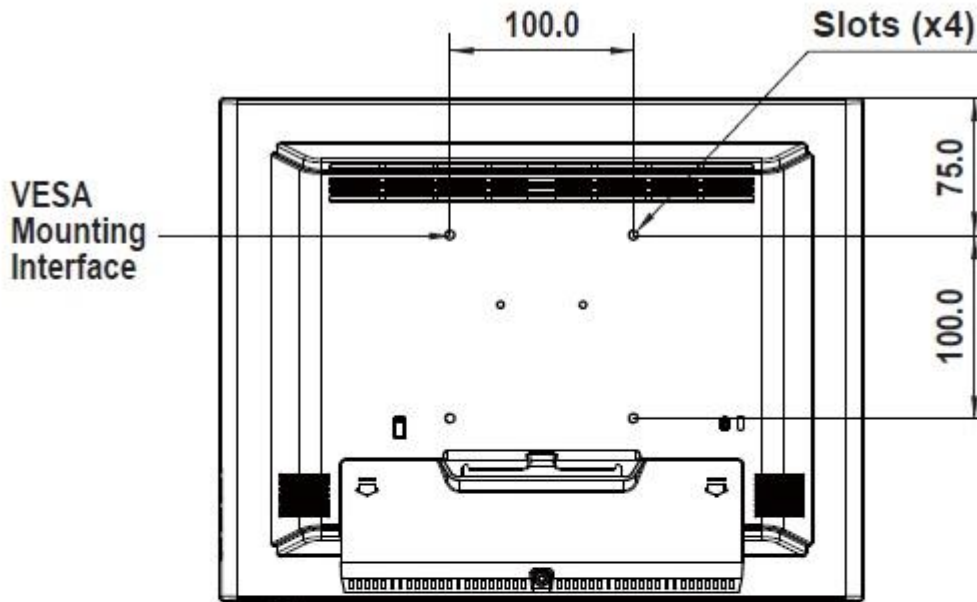

** Warning!**

***Please select the proper screws!***

***The distance between the back cover surface and the bottom of the screw hole is 11 mm. Please use four M4 screws diameter with proper length to mount your monitor.***

***Please note: the mounting stand must be able to support at least 11 lbs ( 5Kg).***

## LCD Display Operation

### 8.1 Simple Troubleshooting Guide

#### 8.1.1 Brief FAQ

1. What if the display has no power after you push the power button?
  - a. Make sure your power resource is working and your power cord is securely connected into the plug-in.
  - b. If you have a power switch, please check to make sure the switch is in the on position.
  - c. Check all sources of power to make sure that they are properly installed and connected to allow for proper electricity flow.
2. What if there are strange lines on my LCD monitor when I shut down the PC?
  - a. You can use the auto-adjust function to adjust the horizontal/vertical phase and pixel frequency in order to solve this kind of problem.
3. What if my LCD monitor screen keeps blinking?
  - a. Please check you're VGA or DVI connector to make sure the connector is connected well.
  - b. You may also check your pins of the connector ensure that none are bent or missing.
4. Warning Signals:
  - a. If you see warning messages on your LCD screen, this means that the LCD display cannot receive a clean signal from the computer graphics card. Below are three kinds of Warning Signals. Please check the cable connections or contact your local dealer or our service center for more information.
    - 1. No Signal**
      - a. This message means that the LCD display has been powered on but it cannot receive any signal from the computer graphics card. Check all the power switches, power cables, and VGA/DVI signal cables.
    - 2. Going to Sleep**
      - b. The LCD display is under the power saving mode. The LCD display will enter power saving mode when experiencing a sudden signal disconnecting problem. The monitor can be activated by pressing any keyboard, triggering the mouse or touching the screen.
    - 3. Out of Range**
      - c. This message means that the signal of the computer graphic card is not compatible with the LCD display.

### 8.1.2 Additional Troubleshooting Chart:

If your monitor fails to operate correctly, consult the following chart for possible solution before calling for repairs:

Condition	Check Point
1. The picture does not appear	<ul style="list-style-type: none"><li>• Check if the signal cable is firmly seated in the socket.</li><li>• Check if the Power is ON at the computer</li><li>• Check if the brightness control is at the appropriate position, not at the minimum.</li></ul>
2. The screen is not synchronized	<ul style="list-style-type: none"><li>• Check if the signal cable is firmly seated in the socket.</li><li>• Check if the output level matches the input level of your computer.</li><li>• Make sure the signal timings of the computer system are within the specification of the monitor.</li><li>• If your computer was working with a CRT monitor, you should check the current signal timing and turn off your computer before you connect the VGA Cable to this monitor.</li></ul>
3. The position of the screen is not in the center	<ul style="list-style-type: none"><li>• Adjust the H-position, and V-position, or Perform the Auto adjustment.</li></ul>
4. The screen is too bright (too dark).	<ul style="list-style-type: none"><li>• Check if the brightness or contrast control is at the appropriate position, not at the Maximum (Minimum).</li></ul>
5. The screen is shaking or waving	<ul style="list-style-type: none"><li>• Press  (the Auto - adjustment control) to adjust.</li><li>• Moving all objects which emit a magnetic field such as motor or transformer, away from the monitor. Check if the specific voltage is applied.</li><li>• Check if the signal timing of the computer system is within the specification of monitor.</li></ul>

For more information, please go to the website <http://www.aispro.com> and contact technical support to help resolve your issue. You can also e-mail support at [support@aispro.com](mailto:support@aispro.com). We will be happy to help.

## **Appendix**

### **9.1 Cleaning the Monitor**

1. Make sure the monitor is turned off.
2. Never spray or pour any liquid directly on the screen or case.
3. Wipe the screen with a clean, soft, lint-free cloth. This removes dust and other particles.
4. The display area is highly prone to scratching. Do not use Ketone type material (ex. Acetone), Ethyl Alcohol, Toluene, Ethyl Acid or Methyl Chloride to clear the panel. It may permanently damage the panel and void the warranty.
5. If it is still not clean enough, apply a small amount of non-ammonia, non-alcohol based glass cleaner onto a clean, soft, lint-free cloth, and wipe the screen.
6. Don't use water or oil directly on the monitor. If droplets are allowed to drop on the monitor permanent staining or discoloration may occur.



## **9.2 Touch Screen Driver Installation**

The monitor is available with USB connection. The Linux kernel 2.6.x (32 bit & 64 bit) touch driver is located on the enclosed CD-ROM. HID for Windows® 7, VISTA , XP, 2000, ME, 98.

### **Please Note:**

The system requires 15 seconds for Windows® 7 to install/uninstall the touch drivers. Do not turn power on/off or plug/unplug the USB cable.

### **Driver Install Instructions:**

If you are using a PC running driver Linux kernel 2.6.x (32 bit & 64 bit), follow the instructions below:

1. Power on the PC.
2. Be sure the USB cable is connected from the PC to the LCD display.
3. Open the CD-ROM.
4. Follow the step-by-step instructions as shown on the pop-up windows.

**If you are using a PC running Windows® XP Embedded, follow the instructions below:**

### **Express:**

1. Power on the computer.
2. Make sure that the USB cable is connected to the computer.
3. Be sure that your EWF is disabled. If your EWF is enabled, please disable the EWF by using the EWF Manager command.
4. Once the EWF is disabled click on the XP driver on the CD-ROM and follow the step-by-step instructions as shown on the pop-up windows.

### **Custom:**

1. Power on the computer.
2. Make sure that the USB cable is connected to the computer.
3. Follow the step-by-step instructions found in the folder file on the CD-ROM.

**If you are using a PC running Windows® CE, follow the instructions below:**

1. Power on the computer.
2. Make sure that the USB cable is connected to the computer.
3. Using Platform Builder, build an image file by following the step-by-step instructions found in the folder file on the CD-ROM.

**If you are using a PC running Linux or Apple® Mac OS, follow the instructions below:**

1. Power on the computer.
2. Make sure that the USB cable is connected to the computer.
3. Follow the step-by-step instructions found in the folder file on the CD-ROM.

### **9.3 RMA (Return Material Authorization) Service**

Before returning any goods, please:

1. Contact American Industrial Systems, inc. Technical Support and request for an RMA number (Return Material Authorization).
2. Describe the behavior or reason of unit failure in order to return. Any returns for credit are subject to a restocking fee.
3. Upon confirmation of a hardware failure or valid cause for return, AIS will provide a Return Merchandise Authorization (RMA).
4. Make sure to receive an RMA number from AIS before returning any merchandise. Clearly write or mark this number on the outside of the package you are returning. Any returns without an authorization will be refused and returned to you by the shipper.
5. When returning goods, include the name and telephone number of a person whom we can contact for further explanations if necessary. Where applicable, always include all duty papers and invoice(s) associated with the item(s) in question:
6. Ensure that the unit is properly packed in the original box. A product packaging manual will be included with the replacement Panel or can be emailed to you in advance. Please refer to it for the necessary instructions on how to appropriately package the panel computer being returned. Failure to do so may result in the panel shifting during transit -which may result in physical damage. Physical damage from improper packaging will void your system warranty.
7. Ship the panel back to the address provided on the RMA documentation, via an insured, pre-paid carrier.
8. Return unit must be received to address provided within 30 days, or invoice for full amount will be issued.